

Brazoria Property: 37,770 Acres

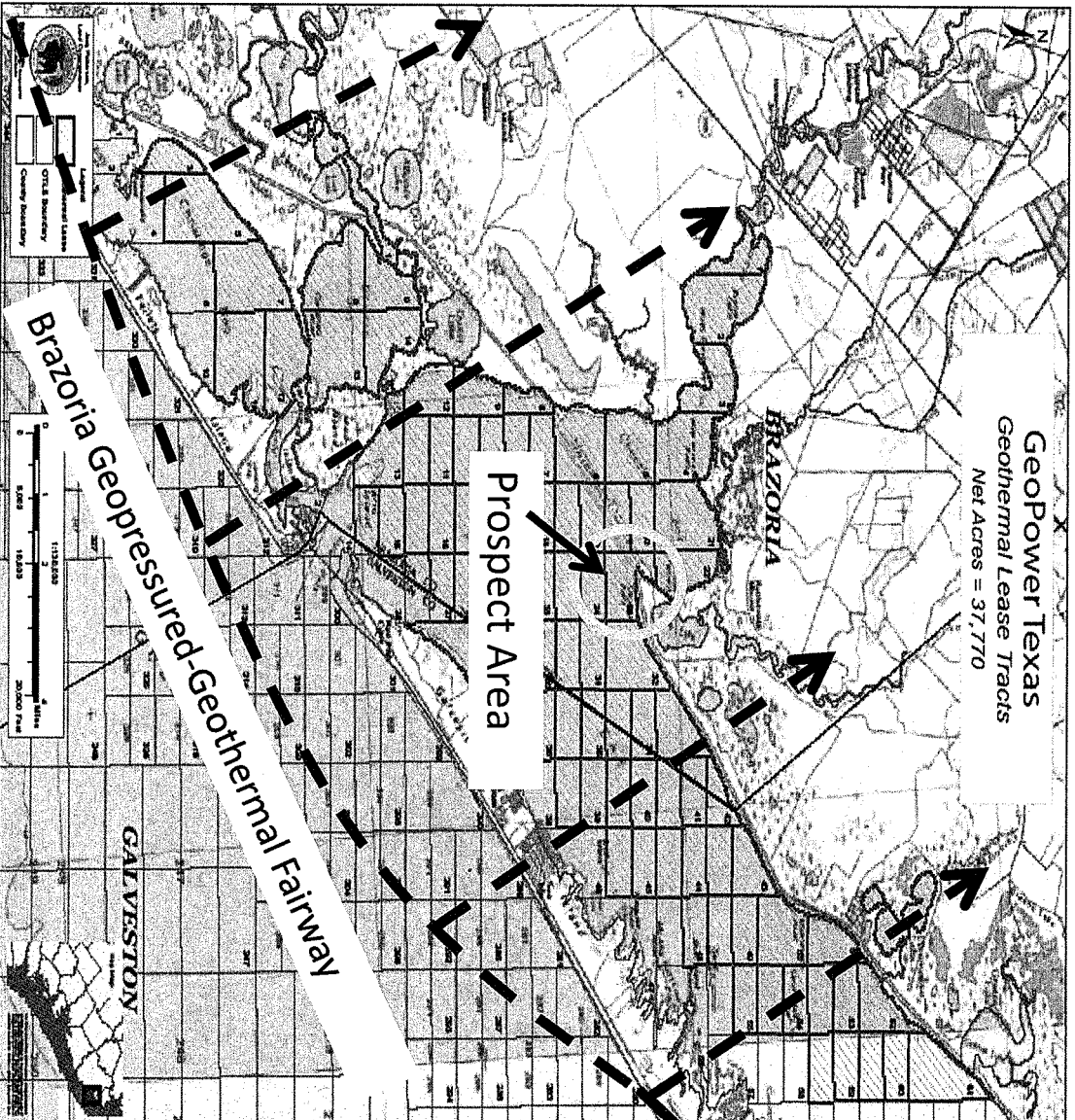

Brazoria Well Location And Nearby Wells

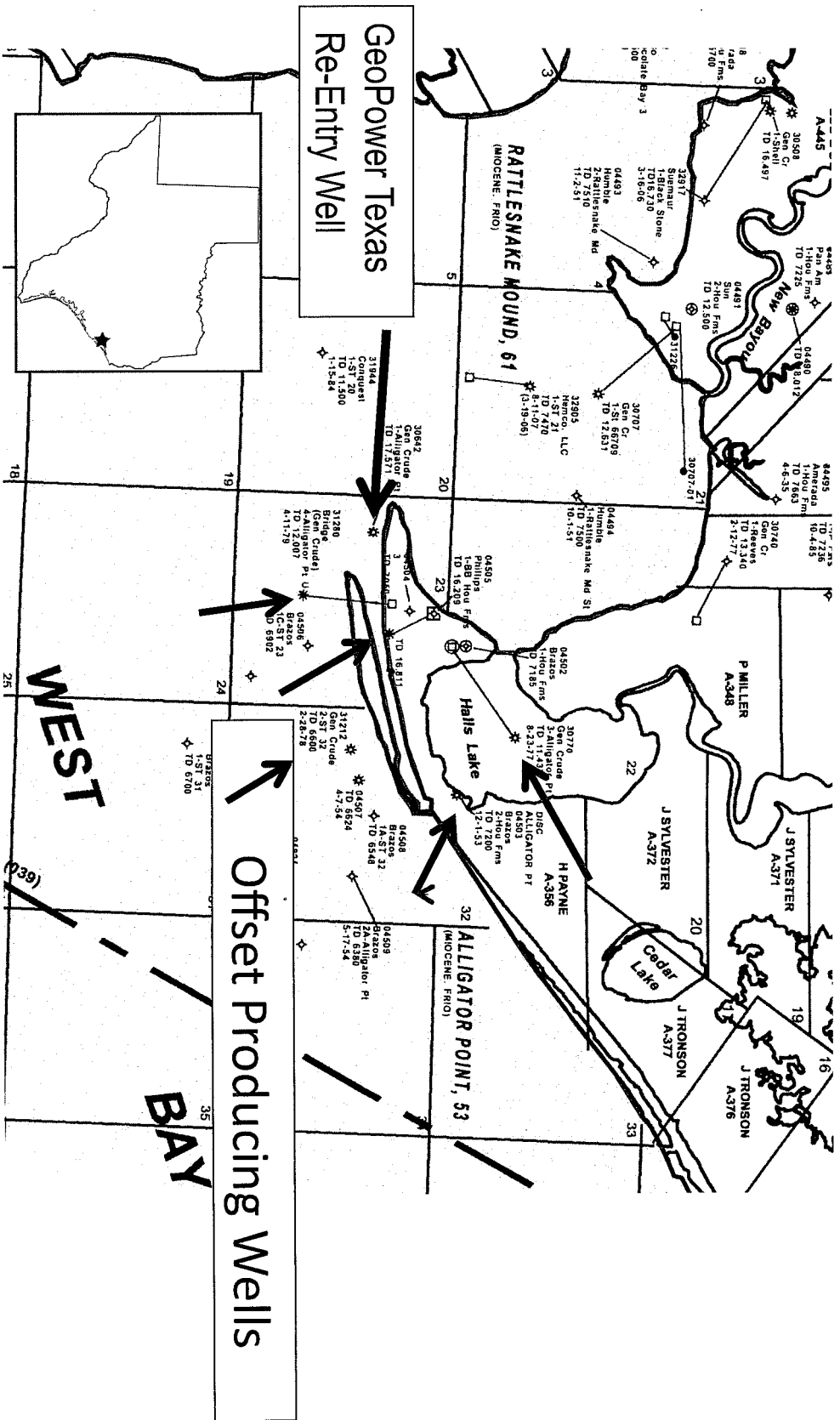

Geopressure Energy Source 1 Thermal: Hot Brines

Confidential

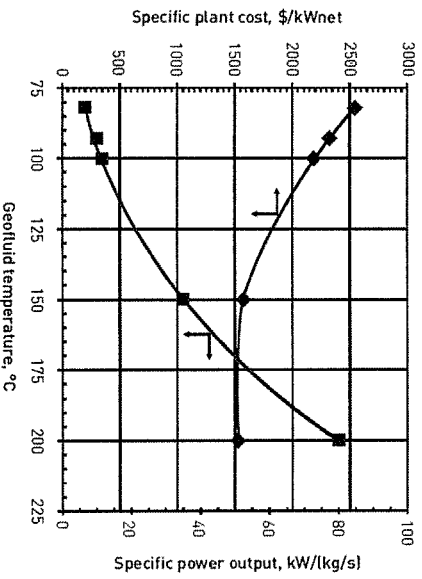

Figure 7.4 Cost and performance of 1 MW binary power plants as a function of geofluid temperature in degrees Celsius (°C).

- Improved output of current binary geothermal turbines: benefit geopressure projects.
- Utilize exhaust heat form natural gas increase brine temperature.

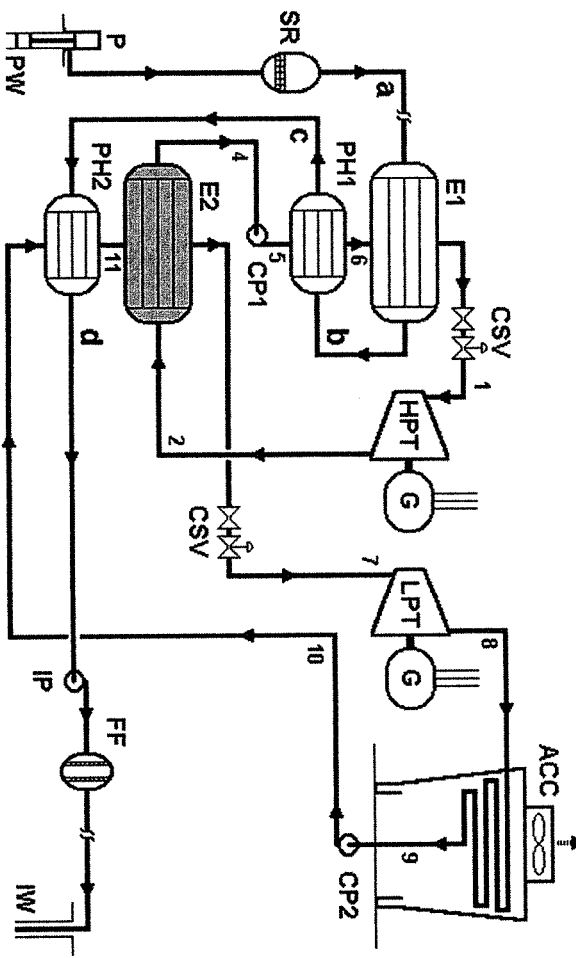
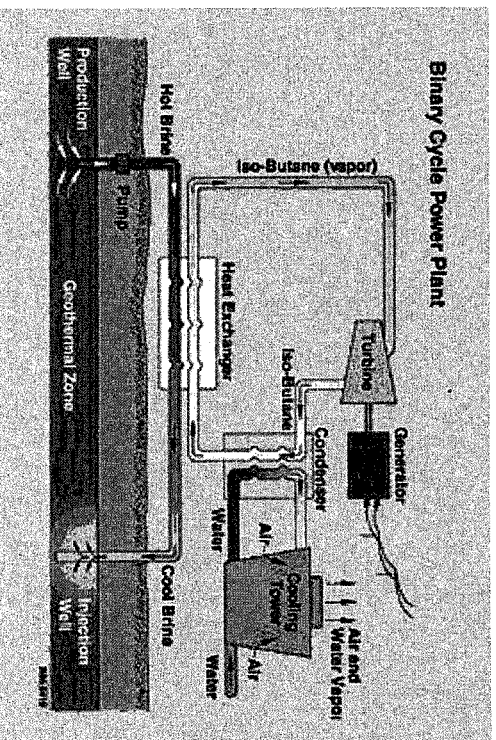

Fig. 8.13 Dual-fluid cascaded binary cycle featuring a heat recuperator.



Geopressure Energy Source 3

Kinetic: Overpressured Hydrostatic Head

Confidential

GE Turbo Expander: Low pressure geothermal Applied engineering to optimize use of high pressure

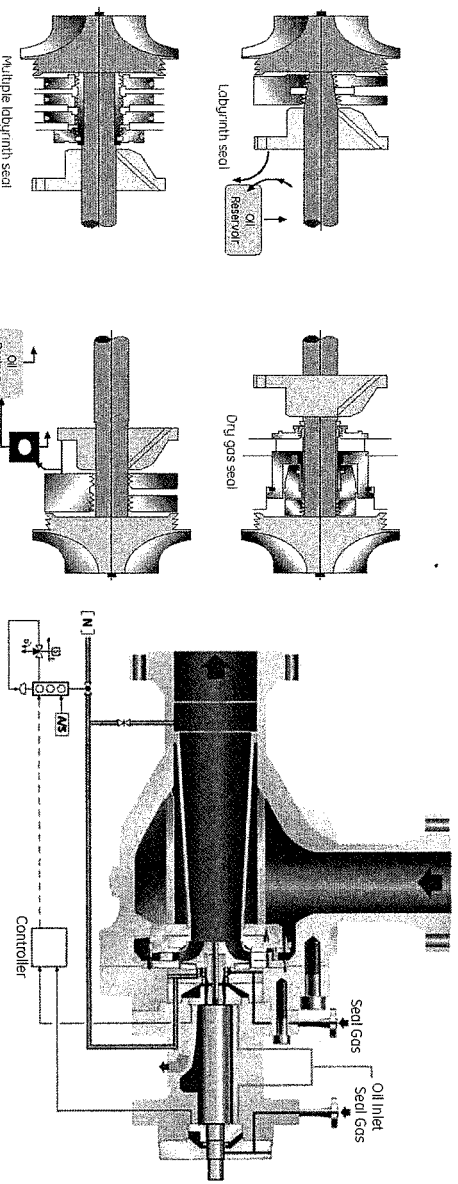

Current design plan is high pressure turbine followed by binary turbine.

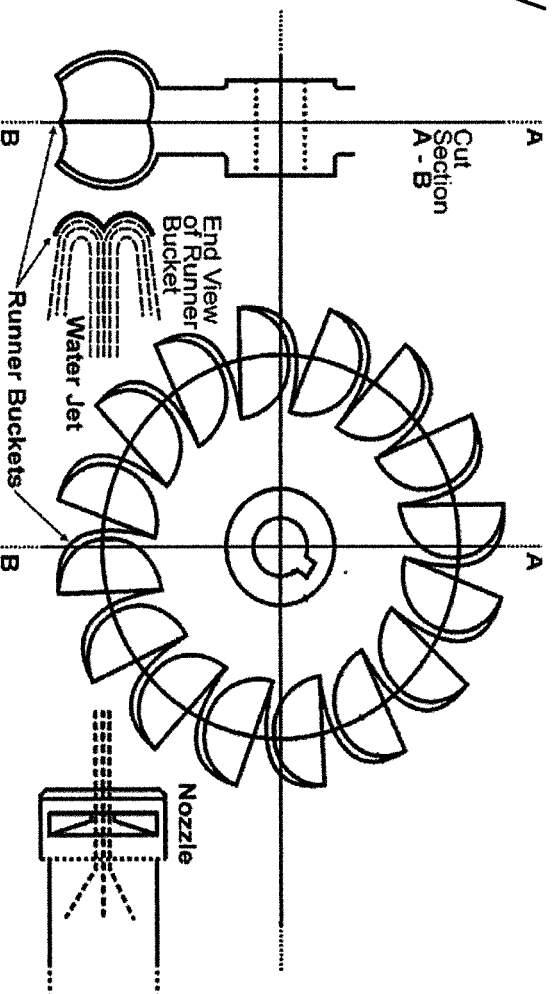

Generic Pelton Wheel

Concept: Combined Power System

Confidential

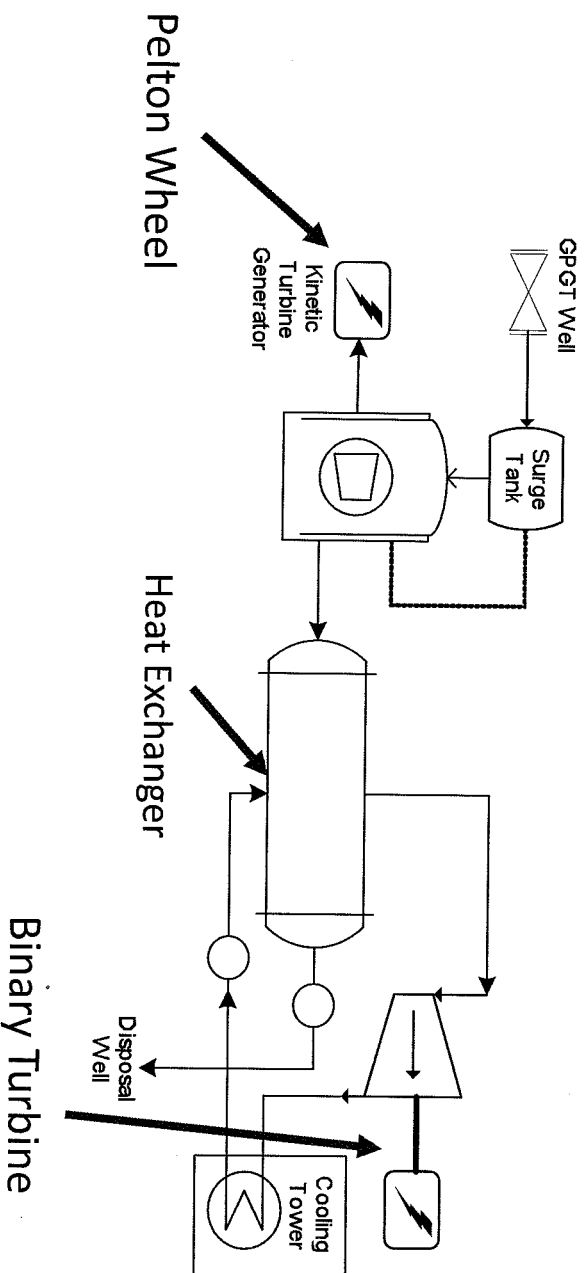

Texas Gulf Coast Electric Transmission Capacity

- Numerous substation sites with capacity available for new plants

ERCOT System Map

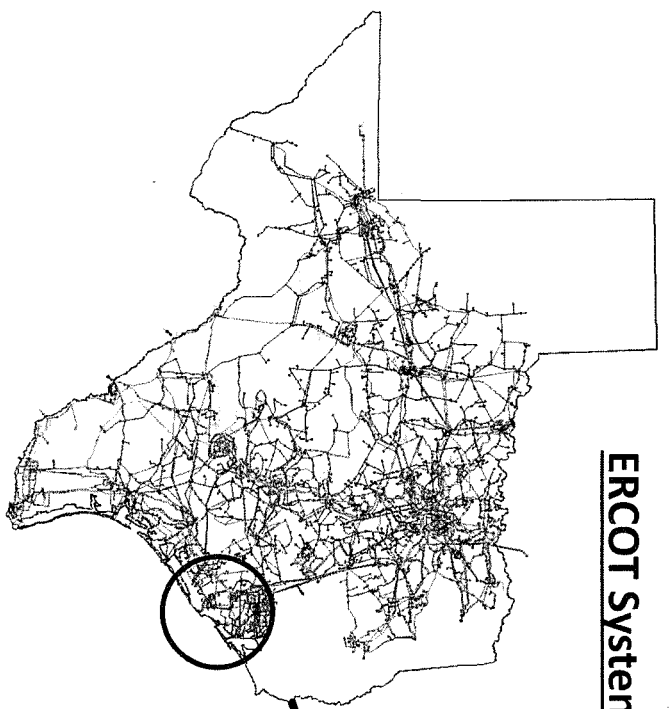

Houston Insert

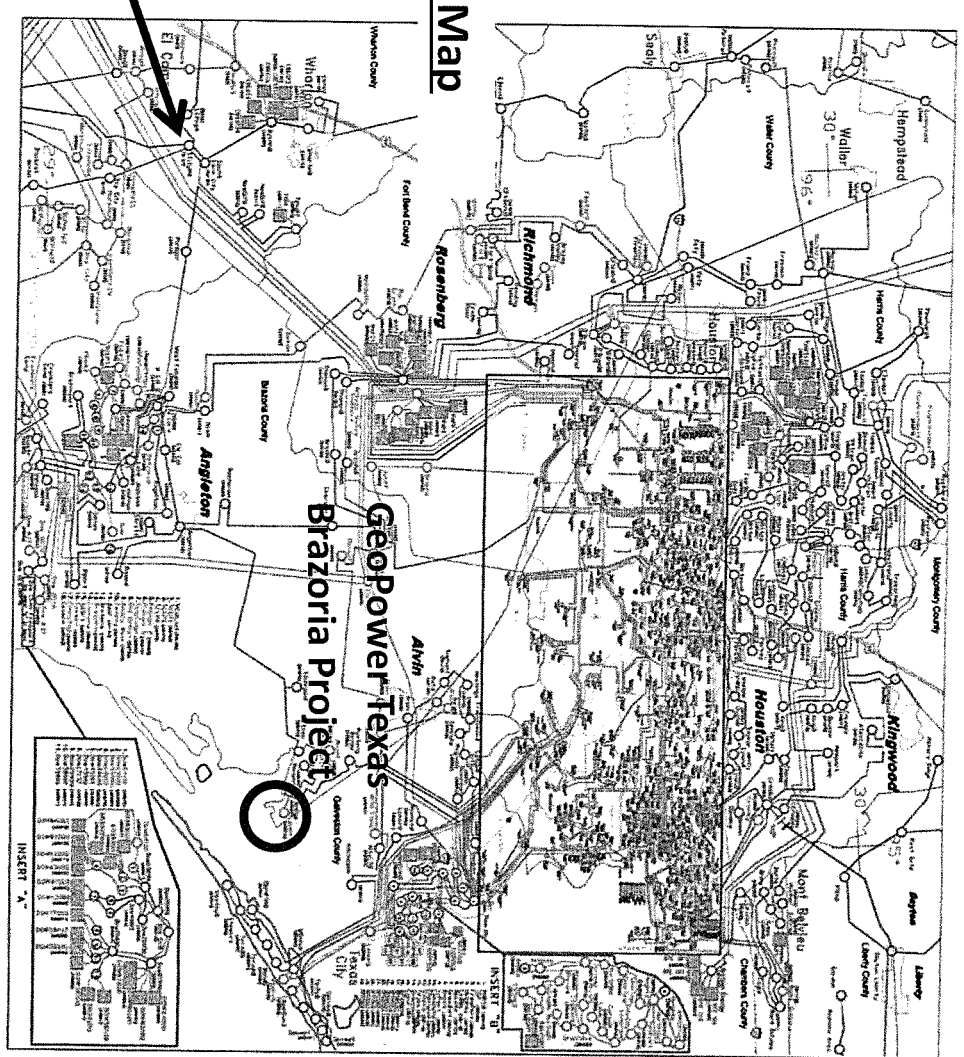

Other Uses: Data Centers, Cquestration, Algae
 Concept Model Only

Confidential

